

# Rotary blade level indicators

## Level limit switches for bulk goods

# DF

# Examples of applications

| Index   | Page |
|---|------|
| Silo Filling with pneumatic conveyor equipment .....                              | 02   |
| Storage bin, Daily service vessels, Function LEDs with collar .....               | 03   |
| Textile silo, Dosing equipment .....  | 04   |
| Installation inside a container, Multiple filling level, Solids in liquids .....  | 05   |
| Hopper, bin, industrial vacuum cleaner, Container .....                           | 06   |
| Screw conveyor, Discharge pipes .....   | 07   |
| Pressure vessel conveyor, Dryer, Aggressive materials, Level adjustment .....     | 08   |
| Filter, Vibration dampening, Mounting varieties .....                             | 09   |
| Example of a plant for bulk goods .....   | 10   |
| Silo with 2 chambers one upon the other .....                                     | 12   |
| Silo plant - PVC, Silo plant - Plastics granule .....                             | 13   |
| Bellow feeder, Wood shavings, Foil strips, Clamp couplings, Dairy couplings ..... | 14   |
| Conveyor belt transfer, Discharge pipe vertical, Weather protection hood .....    | 15   |
| Overview about types and applications .....                                       | 16   |
| GasEx, Gas+DustEx .....   | 18   |
| Gas+DustEx outgassing bulk goods, Gas+DustEx zone 0 inside .....                  | 19   |
| Level measurement in a silo for grain .....                                       | 20   |

**Silo** Filling with pneumatic conveyor equipment

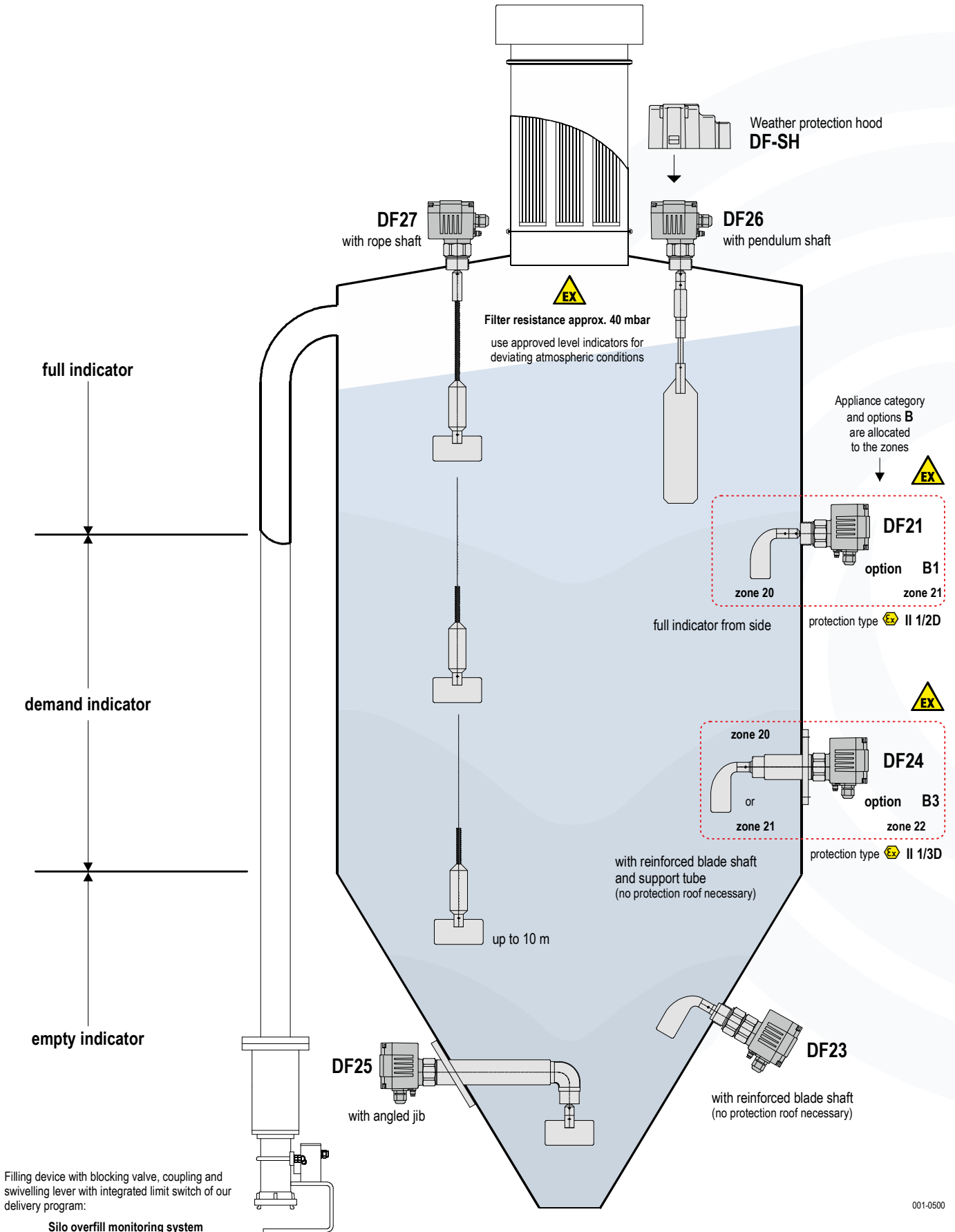

**Storage bin, daily service vessels** Full- and demand indicator with signal lamp

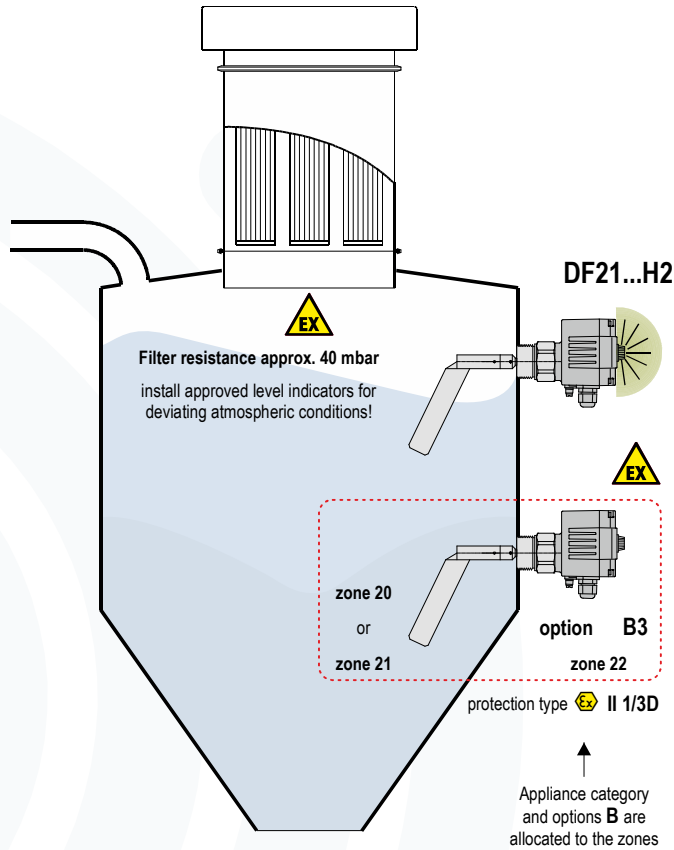

Optical display of the filling levels

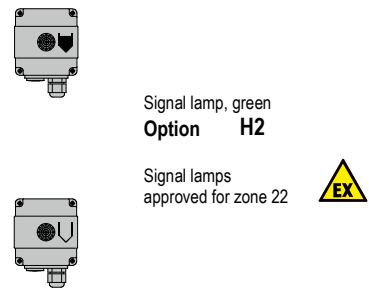

Carried out with longlife supra light LEDs.

Simply calibrating of the display function "full" / "empty" due to changing of a jumper.

001-0501

**Function LEDs with collar**

Collar for function LEDs  
Option H1

Collars approved for zone 22

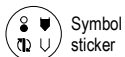
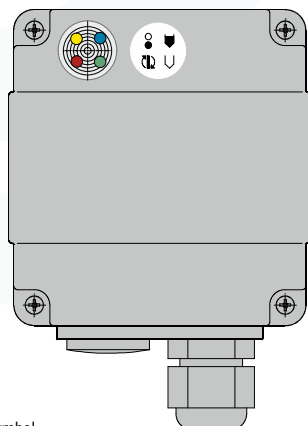

Position of the function LEDs

LED, yellow indicator on "voltage existing"

LED, red "malfunction"  
Option D1

LED, blue above container "full"

LED, green bottom container "empty"

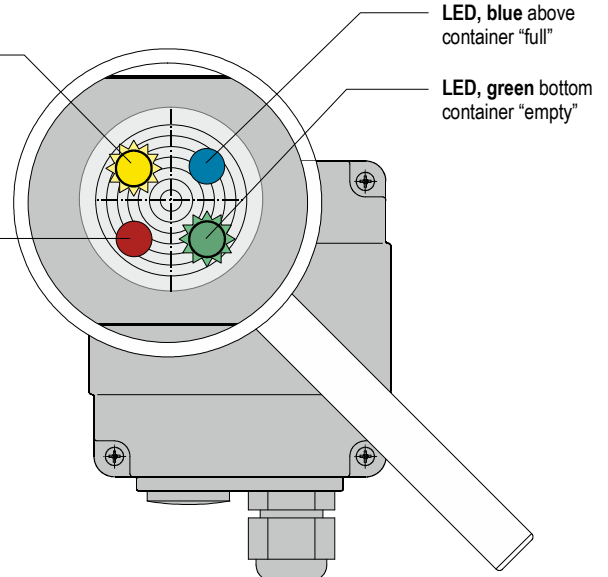

001-0502

**Textile silo**

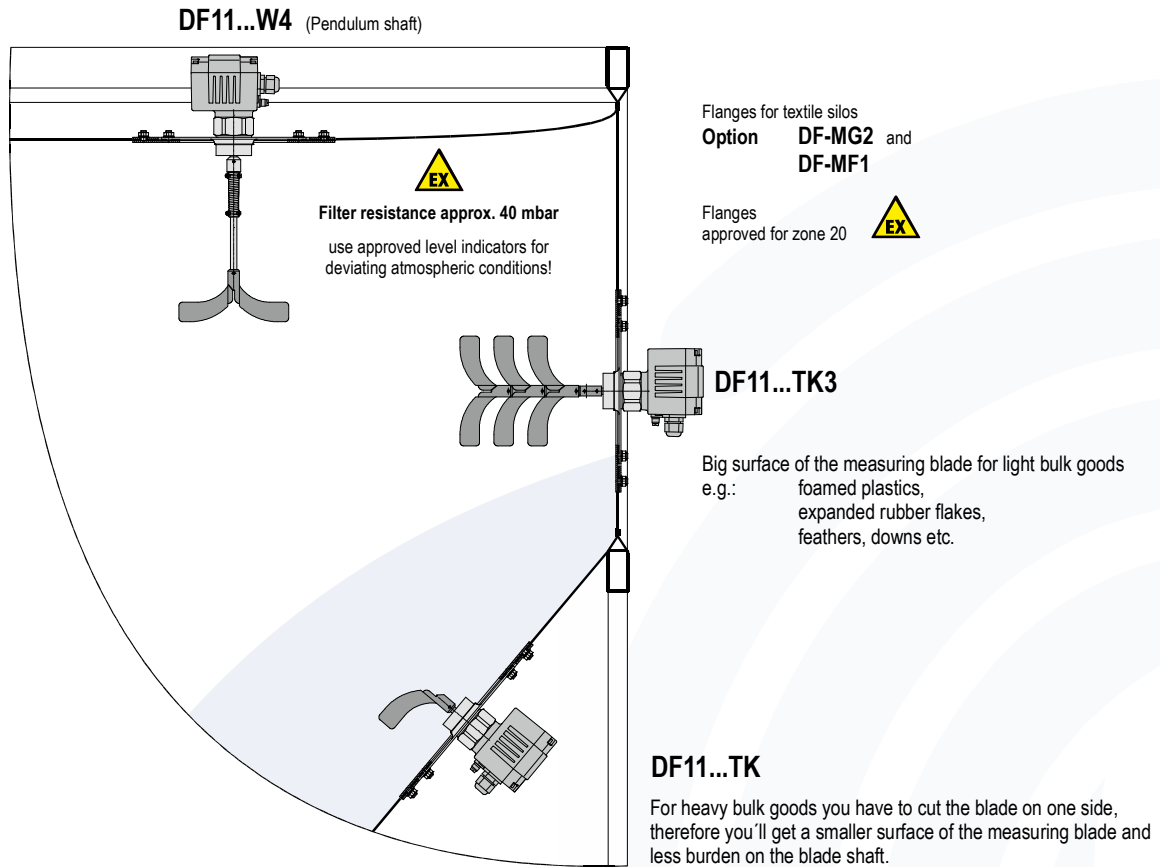

001-0503

**Dosing equipment**

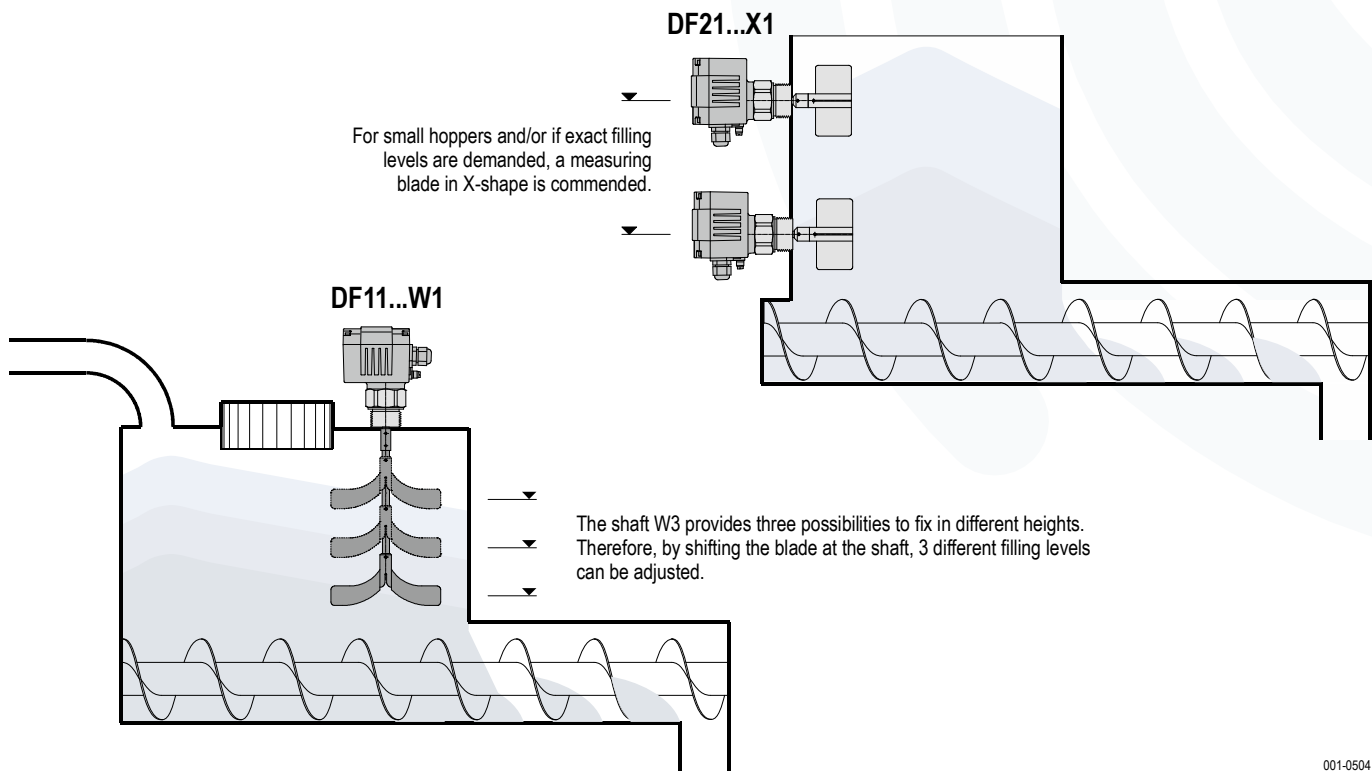

001-0504

**Installation inside of a vessel**

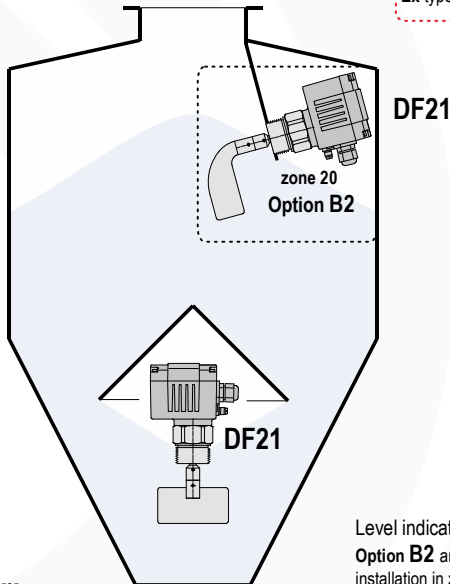
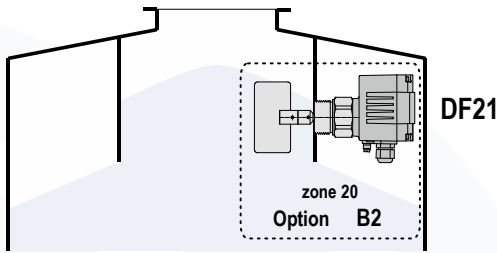

In ATEX areas of zone 20  
Option B2 choose:  
Ex type of protection II 1D

Level indicator with  
Option B2 are certified for  
installation in zone 20 !!!

001-0505

**Multiple filling level indication**

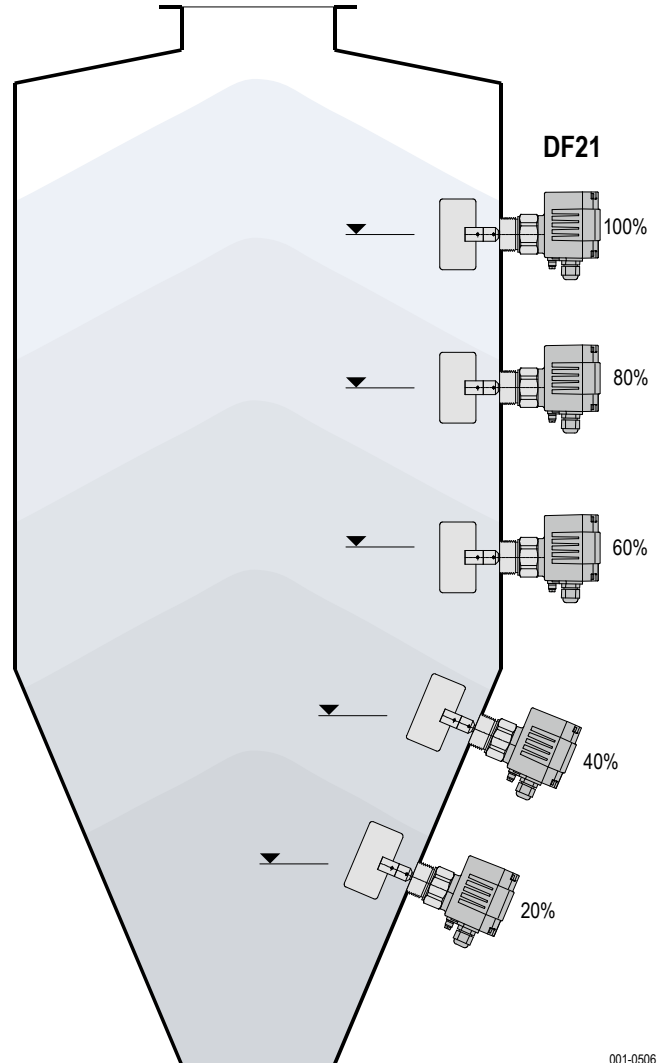

001-0506

**Solids in liquids**

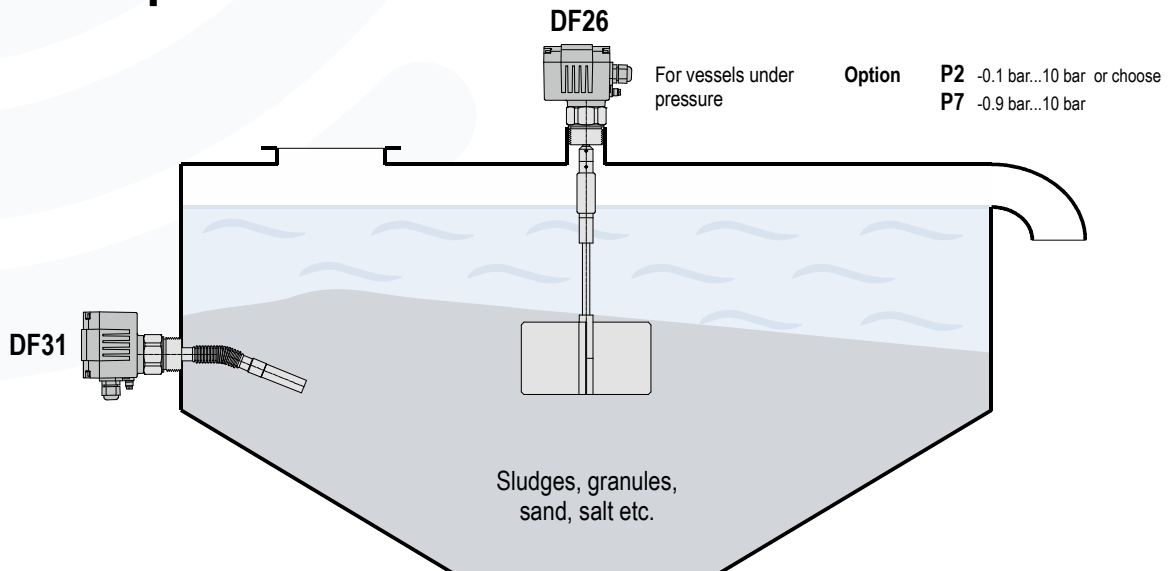

001-0507

**Hopper, bin, industrial vacuum cleaner**

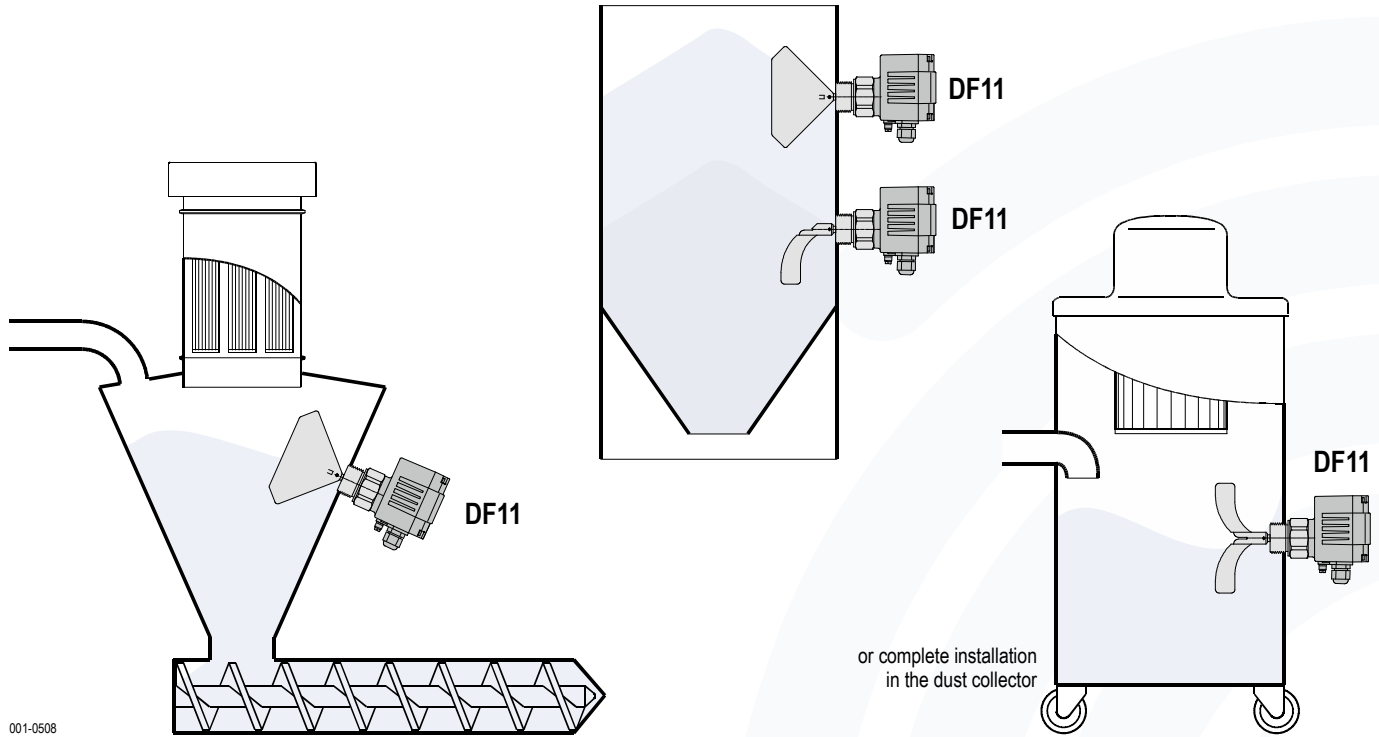

**Container**

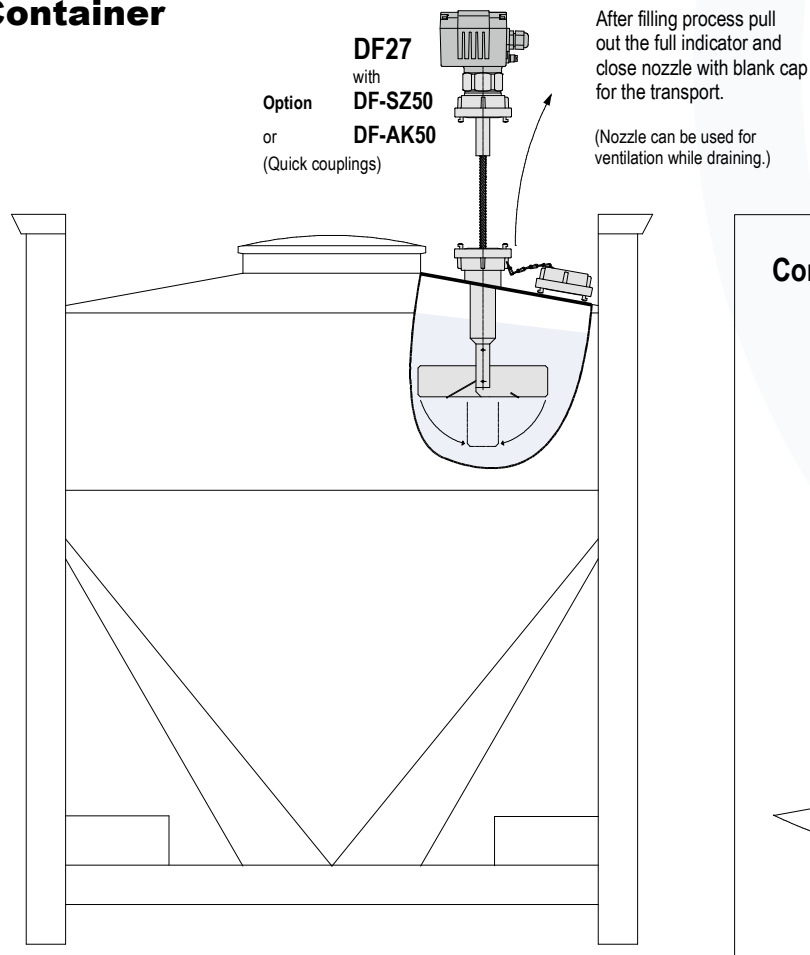

**Container or big-bag**

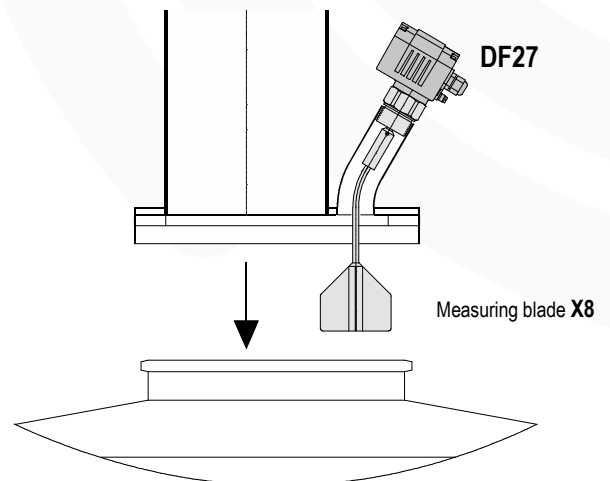

001-0509

**Screw conveyor**

empty indicator

**DF23**

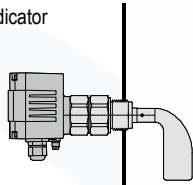

Use level indicators with measuring blade in X-shape.  
(reacts quicker when "full" as a blade with onesided paddle)

In addition to that, depending on the conveying capacity of the screw conveyor, a higher driving speed of the measuring blade can be chosen, e.g. 5 rpm. (short reaction time)

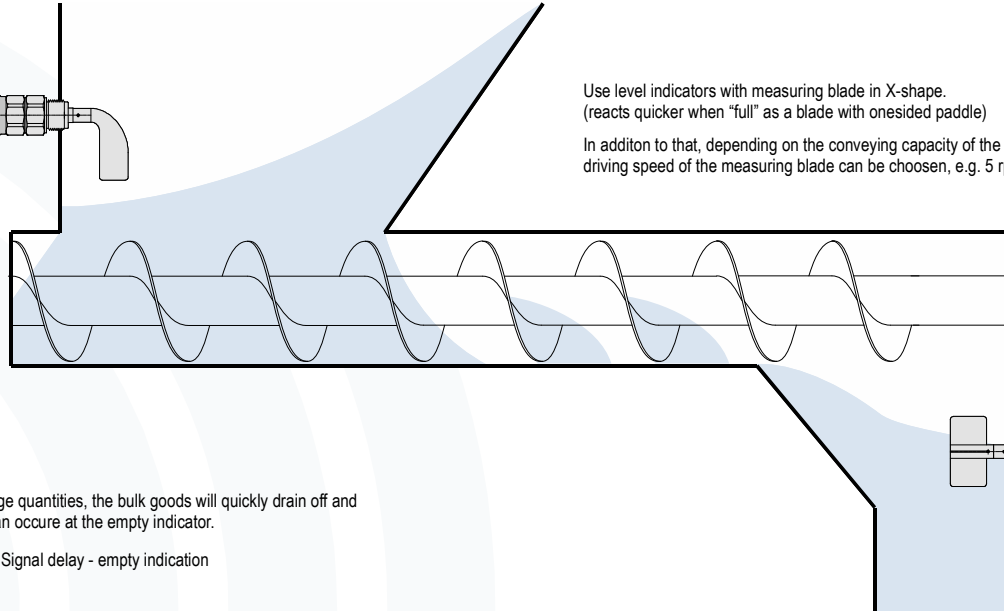

jam indicator

**DF21**

Due to high discharge quantities, the bulk goods will quickly drain off and a faulty switching can occur at the empty indicator.

Use **Option D3** = Signal delay - empty indication

001-0510

**Discharge pipes**

**DF21** full indicator or empty indicator

ATTENTION: This use in light bulk goods, with less conveying capacity and regular delivery line only.  
We recommend to install a protection roof or to set the blade out of the discharge volume, as shown on page 9.

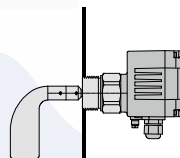

**DF21**

jam indicator, full indicator or empty indicator

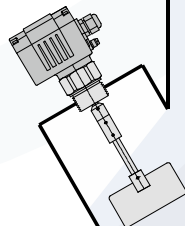

**DF21**

jam indicator, full indicator or empty indicator with large signal lamp **Option H8**

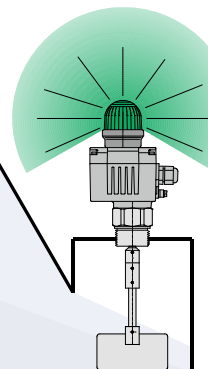

001-0511

**Pressure vessel conveyer**

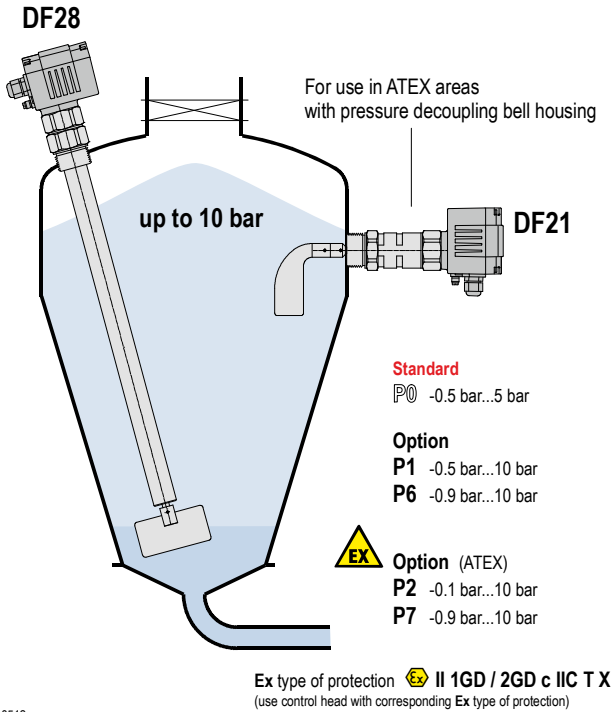

001-0512

**Dryer**

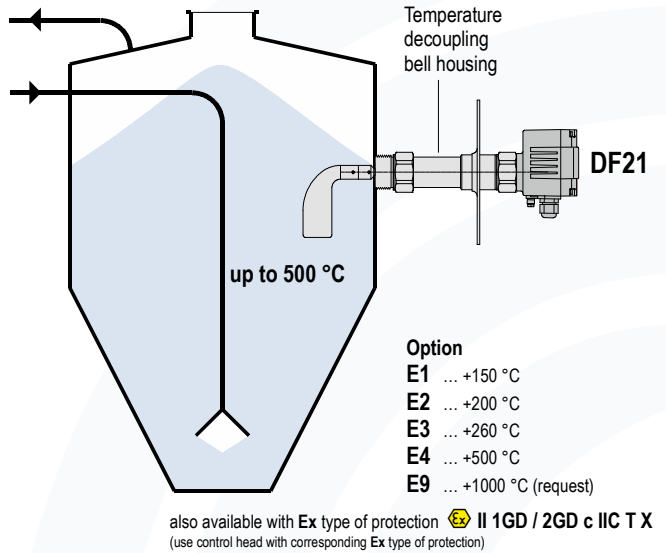

001-0513

**Aggressive materials**

DF31 for use in aggressive bulk goods and/or aggressive gases

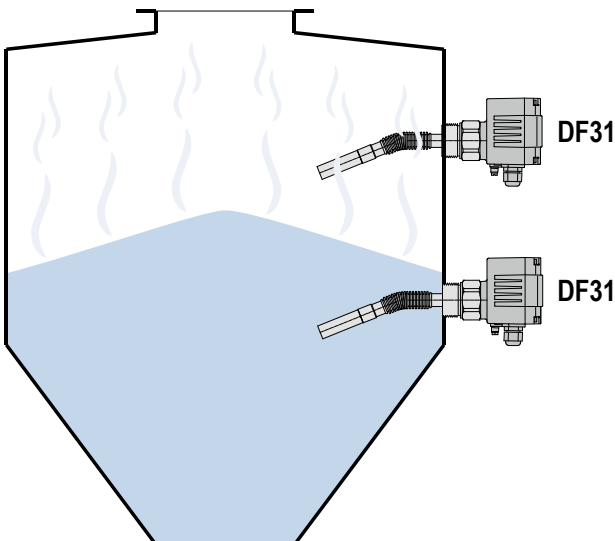

001-0514

**Level adjustment**

also available with Ex type of protection **II 1GD / 2GD c IIC T X**  
(use control head with corresponding Ex type of protection)

The level adjustment allows settings of variable level heights.

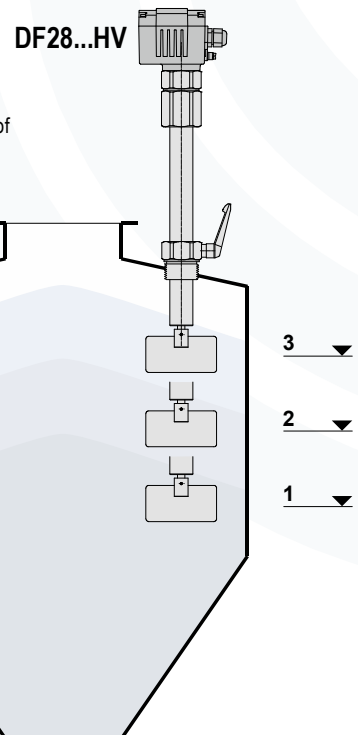

001-0515



**Filter**

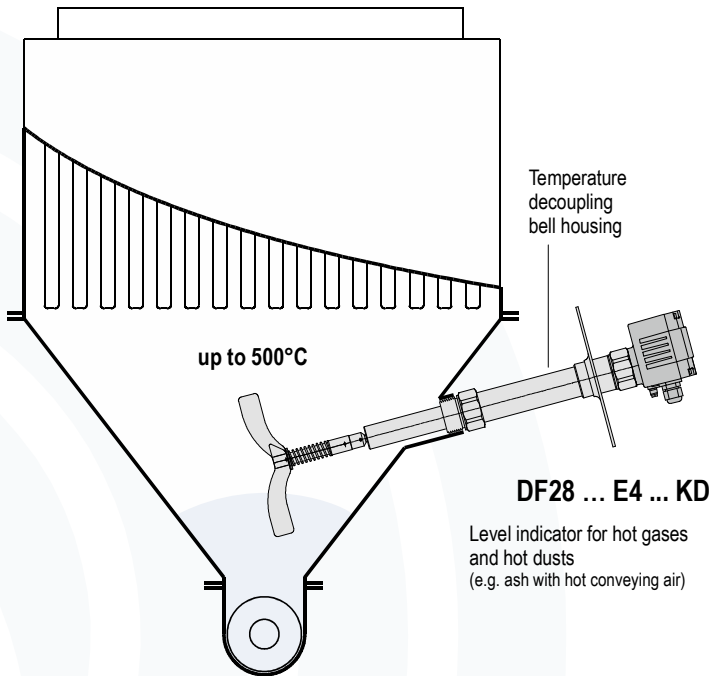

001-0516

**Vibration dampening**

Vibration dampening  
Option **DF-VD**

Damps the transmission of vibrations and shocks at the level indicator

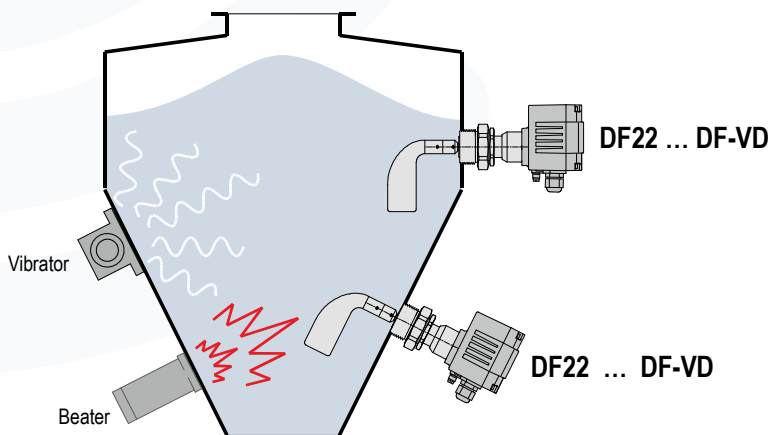

001-0517

**Mounting varieties**

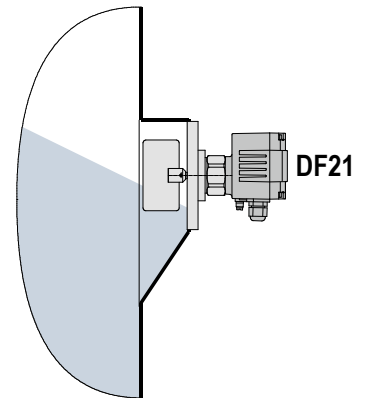

Installation in a "pocket" to protect measuring blade and shaft from too high loads.

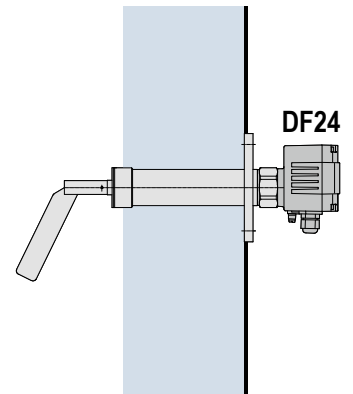

Mounting in thick silo walls (e.g. silos of concrete) or to penetrate thick stickings at the silo wall

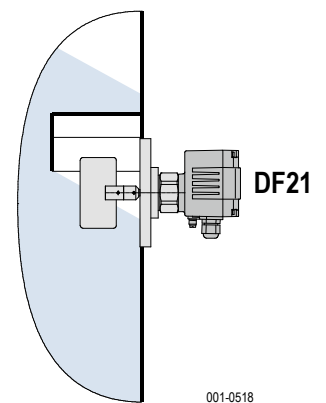

001-0518



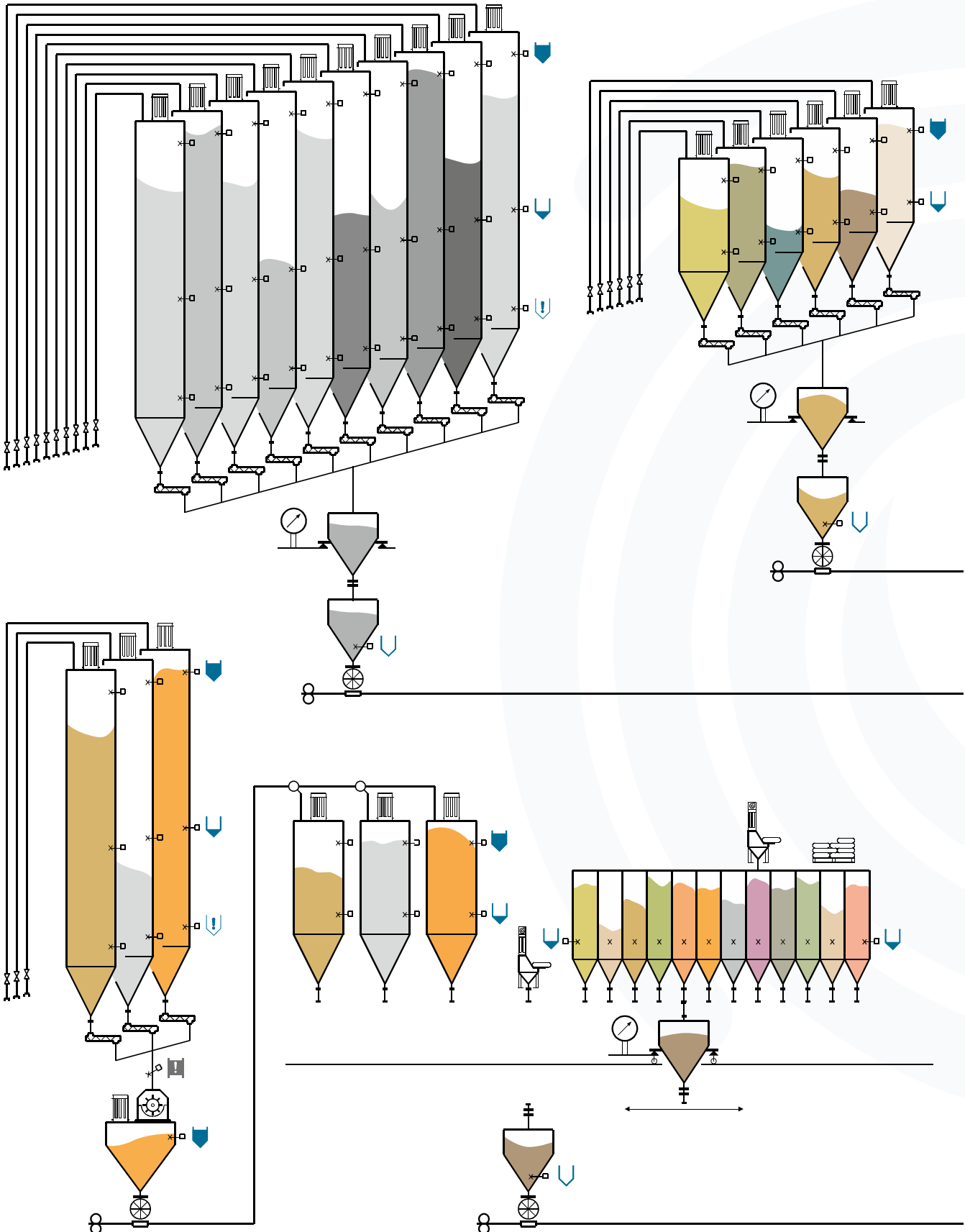

Protection roof above the measuring blade to protect the measuring blade and the shaft from too high loads. e.g. large and heavy bulk material

**Example of a plant for bulk goods** with rotary blade level indicators



001-0519

Rotary blade level indicators are important devices in plant construction and engineering

-  full indicator
-  demand indicator
-  empty indicator
-  alarm indicator
-  jam indicator

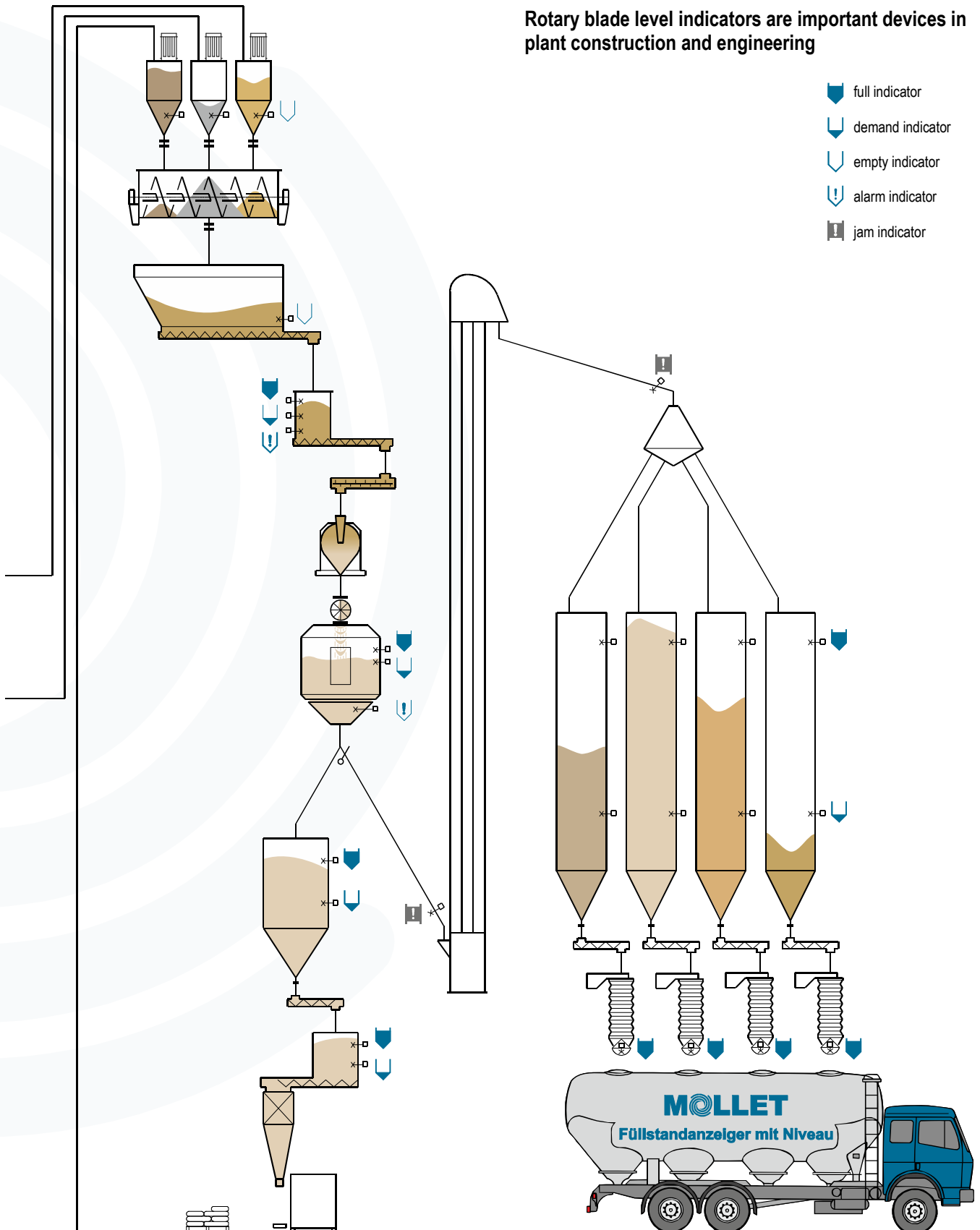

**Silo with 2 chambers one upon the other**  
Filling with pneumatic conveyor equipment

Further devices for a safe operation of silos:

- MOLLET pressure detector
- MOLLET Silo-Ex-Implo-Valve

and from our delivery program:

- MOLLET Silo overfill monitoring system

The device category and options **B** are assigned to the zones below:

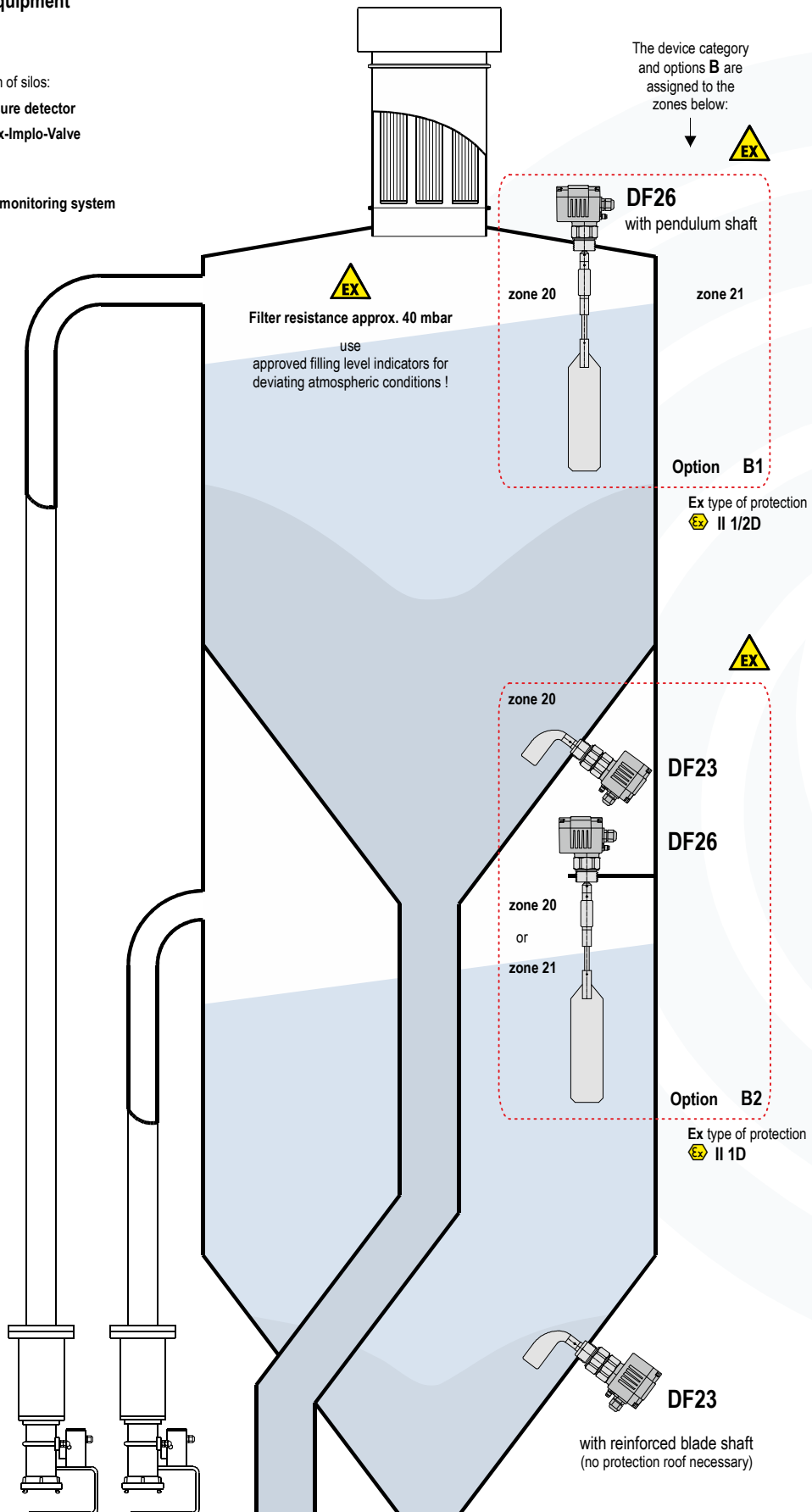

Silo filling device with a blocking valve, a coupling and a swivelling lever with integrated limit switch of our delivery program:

**MOLLET silo-safe-system**

**Silo plant - PVC**

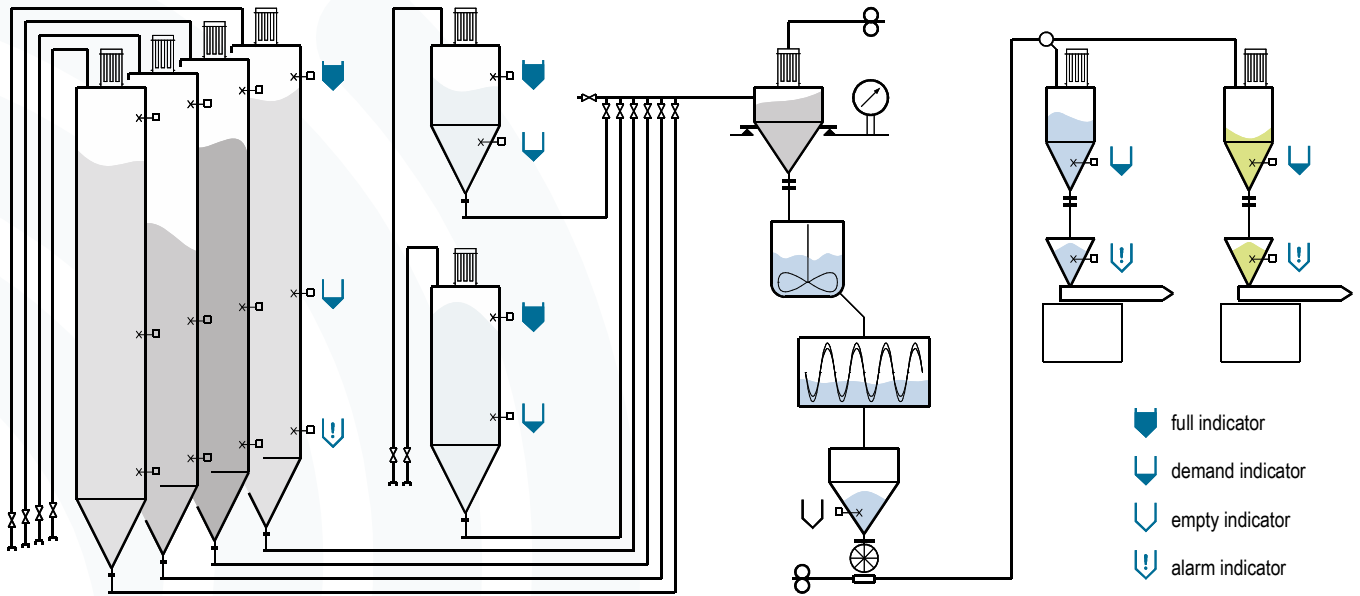

**Silo plant - plastic granulate**

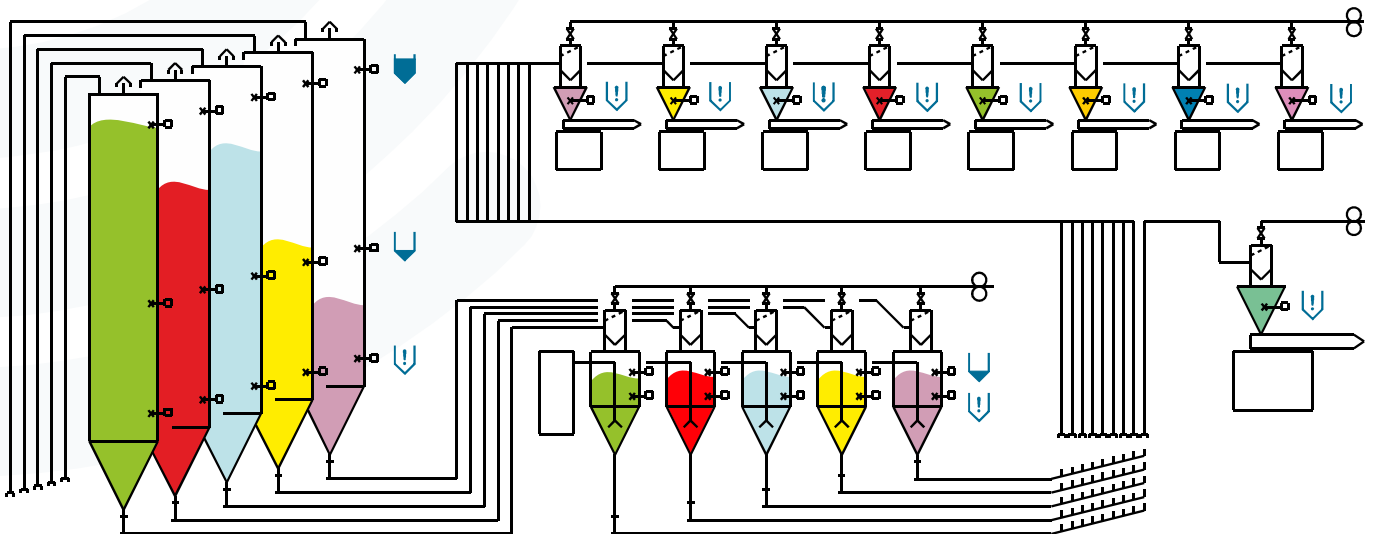

001-0521

**Bellow feeder**

zone 20  
and level indicator installed in the taper closure.

It's not enough to have a taper closure with  
type of protection IP6X.

A EC-type-examination Certificate  
is necessary.

**MOLLET provides the solution !!!**

Rotary blade level indicators witch are Ex-  
certified for installation in  
zone 20.

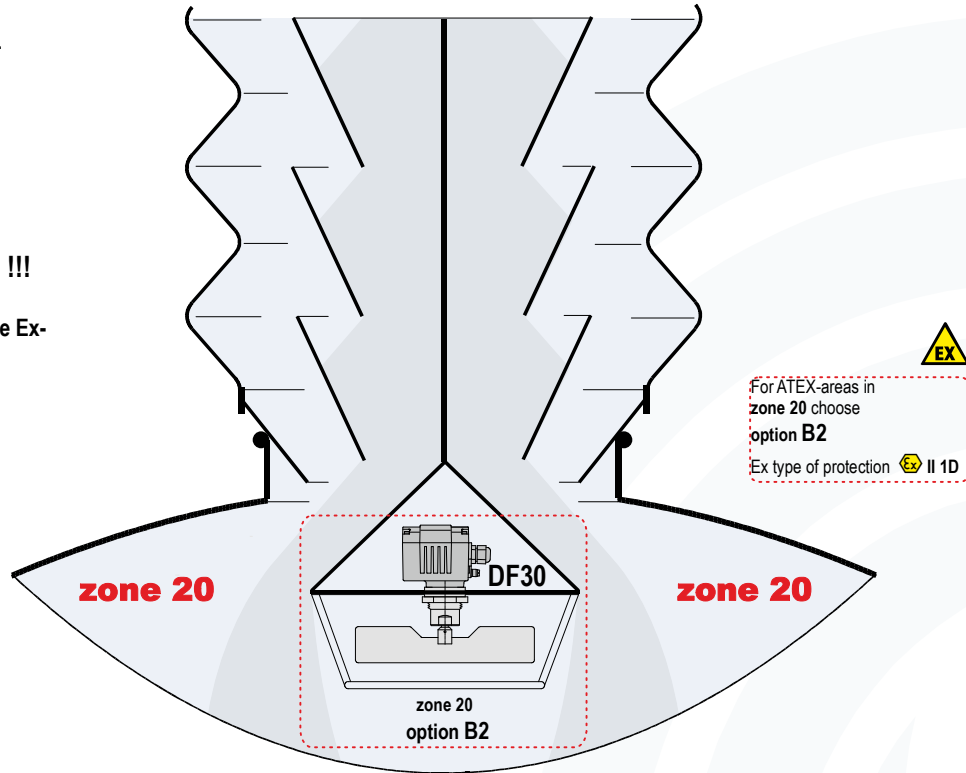

001-0522

**Wood shavings, foil strips**

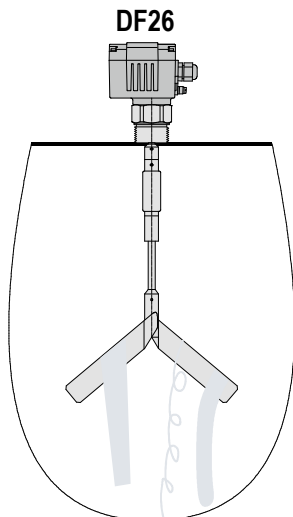

Special measuring blade  
**Option Y2**

For use in:  
Long fiber, wood shavings,  
gauze, tinsel (strips of metal),  
foamed plastic and foil strips,  
sheets etc.

001-0518

**Clamp couplings,  
Dairy couplings**

Stainless steel  
housing and  
FDA-conform type

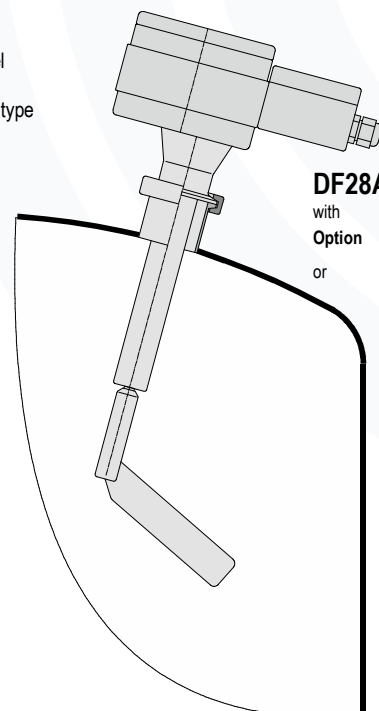

**DF28A4...KD-FDA**  
with  
Option **DF-KV50**  
or **DF-RV50**

001-0523

**Conveyor belt transfer**

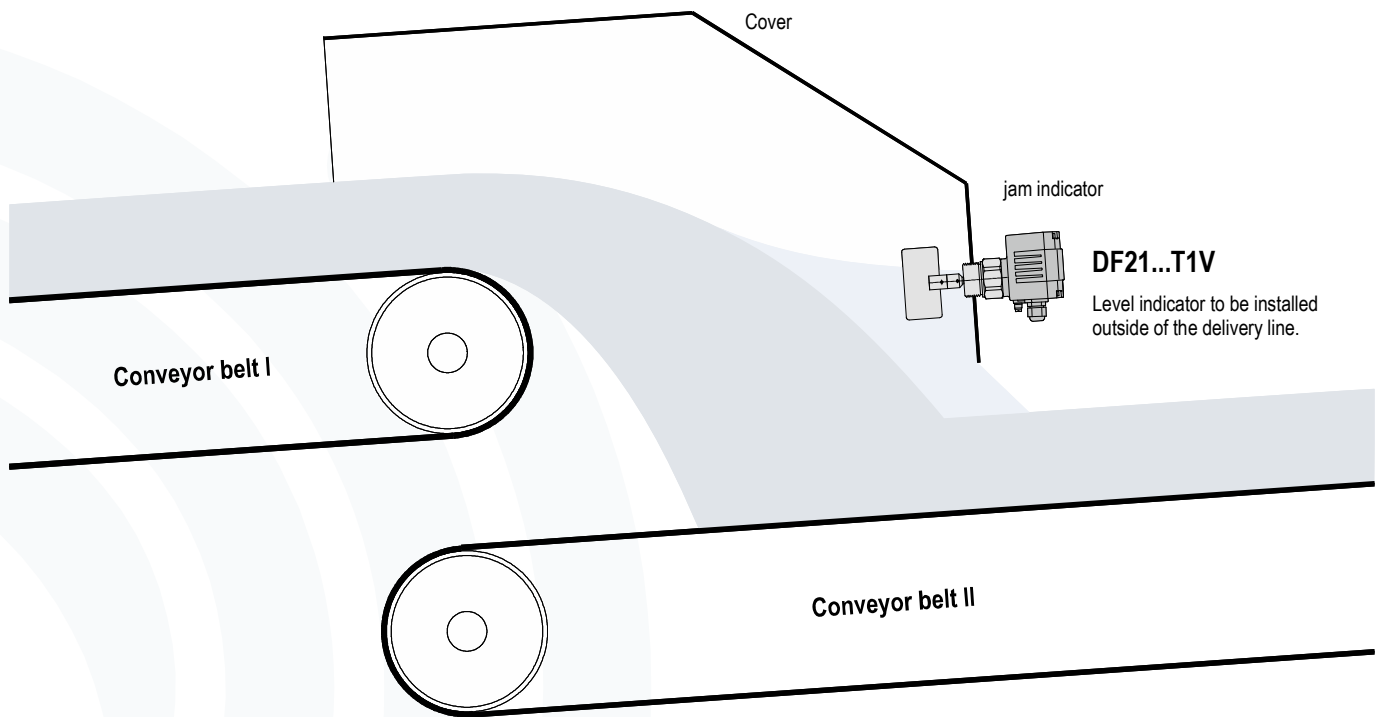

001-0524

**Discharge pipe, vertical**

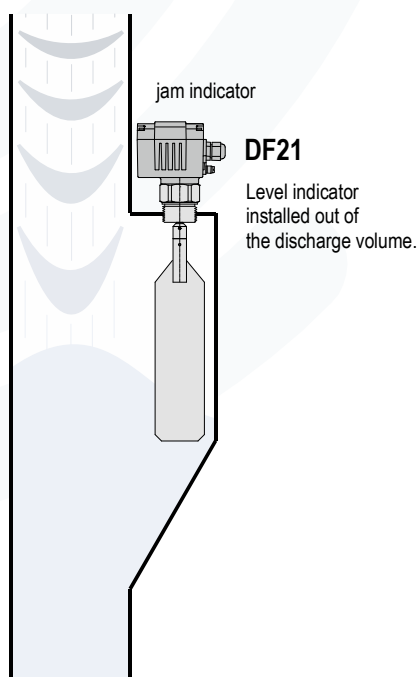

001-0525

**Weather protection hood**

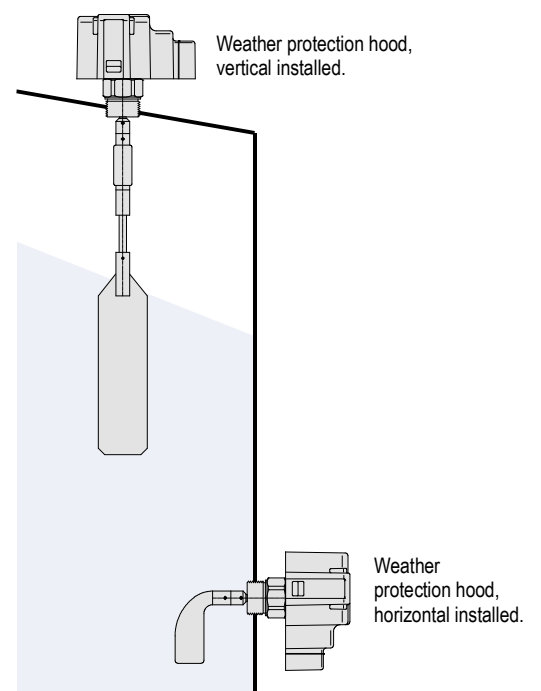

**Type- and Application survey E., P2, ... VD, ... HV, ... DS**

**E1 ... E4 high temperatures**

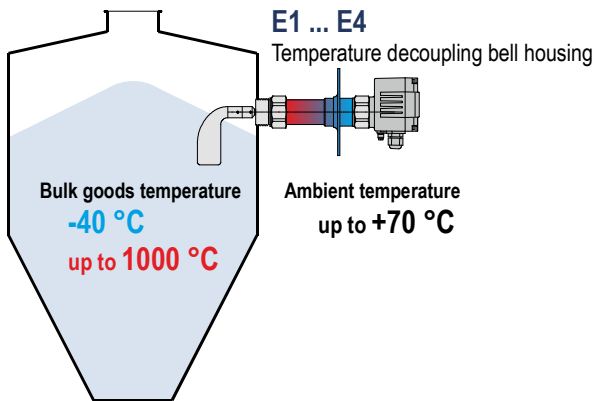

**E7 Appliance heating**

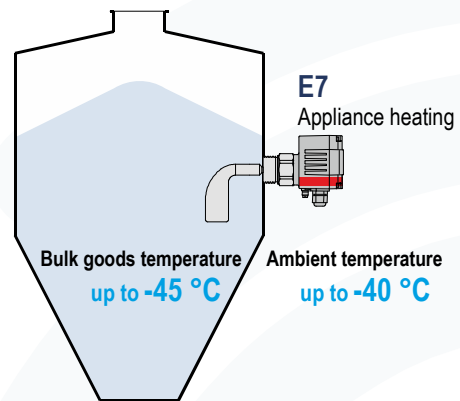

**P2 high process pressure**

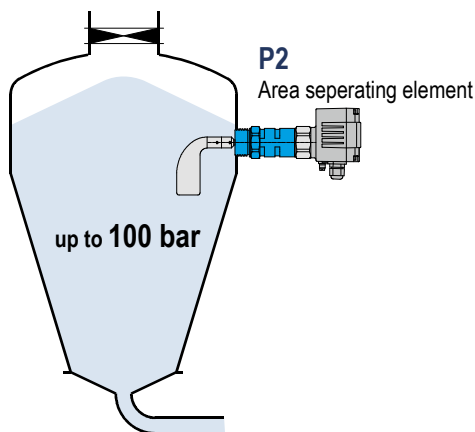

**VD Vibration dampening for DF22**

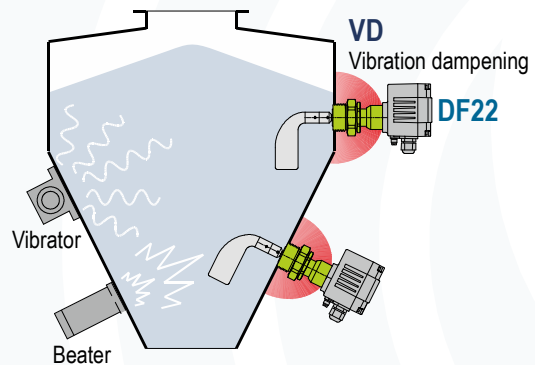

**HV Level adjustment for DF28**

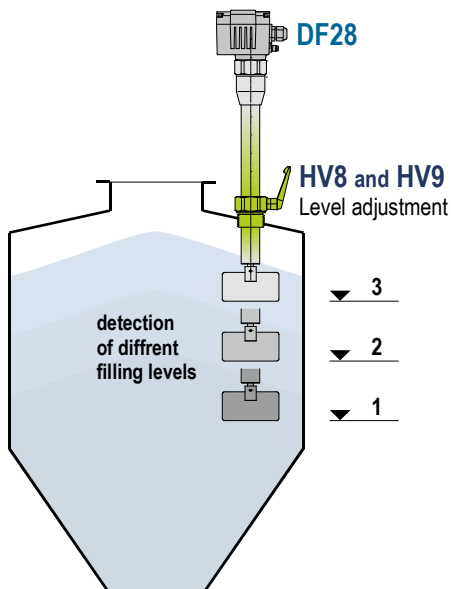

**DS Annular gap flushing**

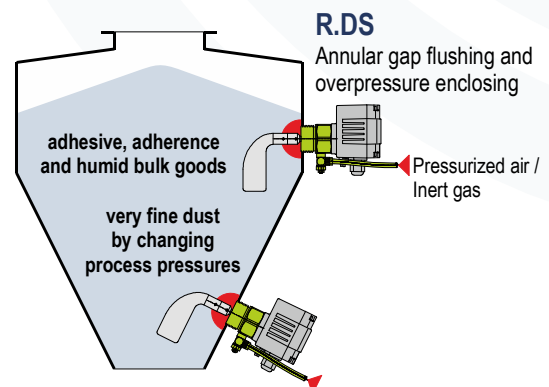



**Type- and Application survey B1, B2, P7, ZTP7, A3, A4**

**B1 Application for DustEx**

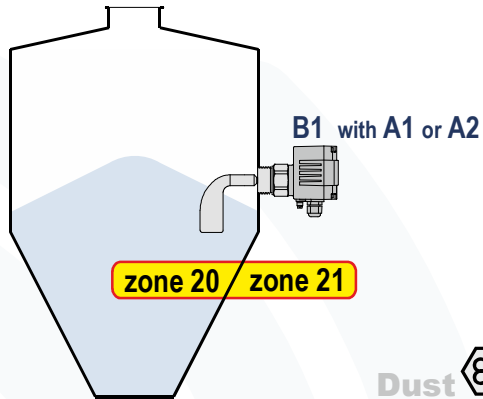

Dust  $\text{Ex}$   
1/2D

**B2 Application for DustEx**

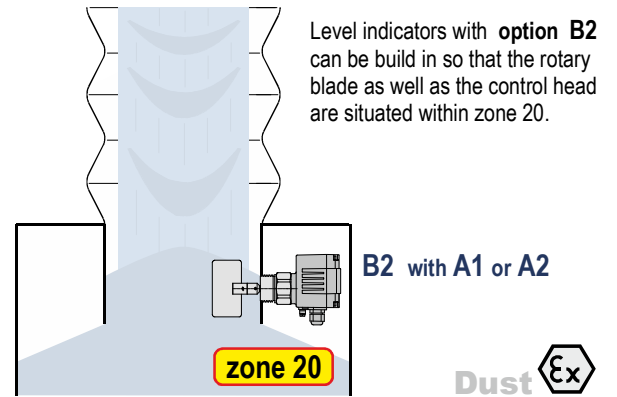

Dust  $\text{Ex}$   
1D

**P7 high process pressure for DustEx**

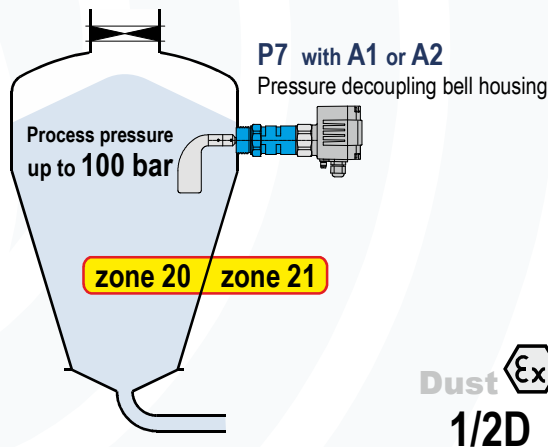

Dust  $\text{Ex}$   
1/2D

**ZTP7 Zone separating for GasEx**

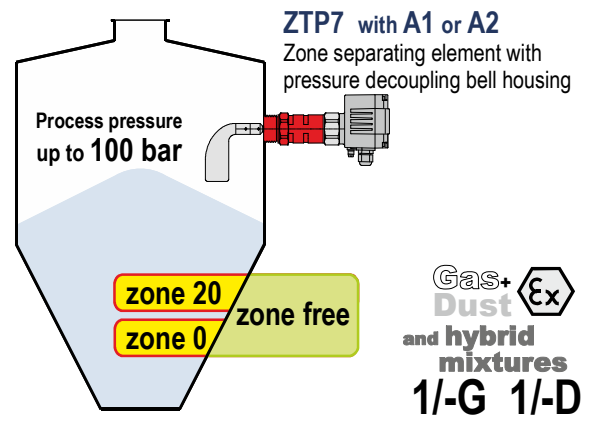

Gas+ Dust  $\text{Ex}$   
and hybrid mixtures  
1-G 1-D

**A3/A4 Devices for GasEx**

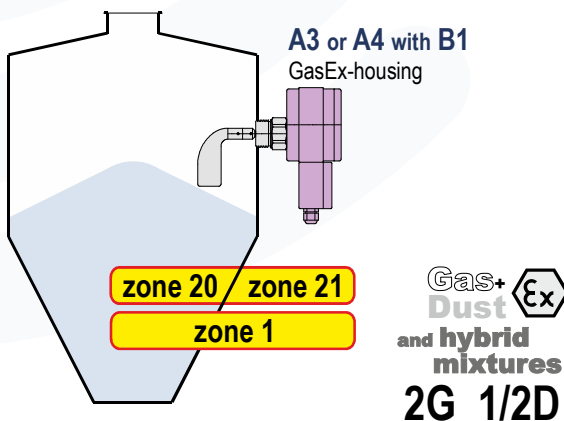

Gas+ Dust  $\text{Ex}$   
and hybrid mixtures  
2G 1/2D

**ZTP7 Zone separating for GasEx**

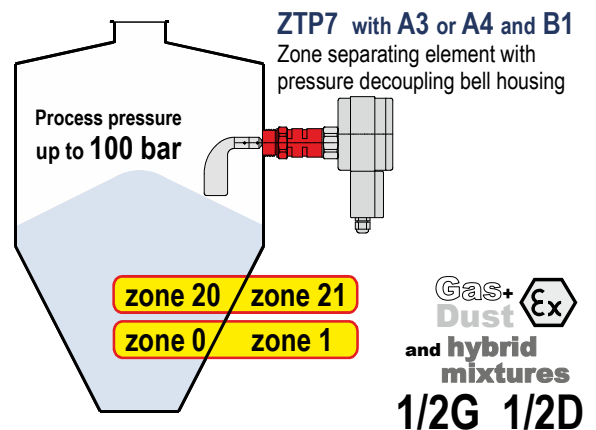

Gas+ Dust  $\text{Ex}$   
and hybrid mixtures  
1/2G 1/2D

Gas 

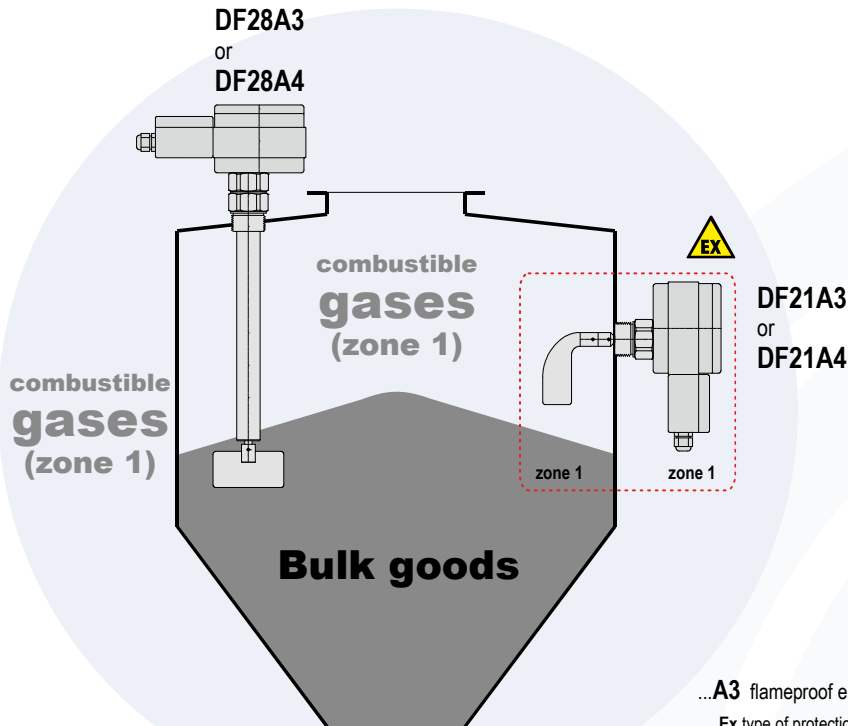

...A3 flameproof enclosed housing in aluminium  
Ex type of protection  II 1D2G/2GD EEx de IIC T6 T70°C IP66

...A4 flameproof enclosed housing in stainless steel  
Ex type of protection  II 1D2G/2GD EEx de IIC T6 T70°C IP66

001-0526

Gas+Dust  and hybrid mixtures

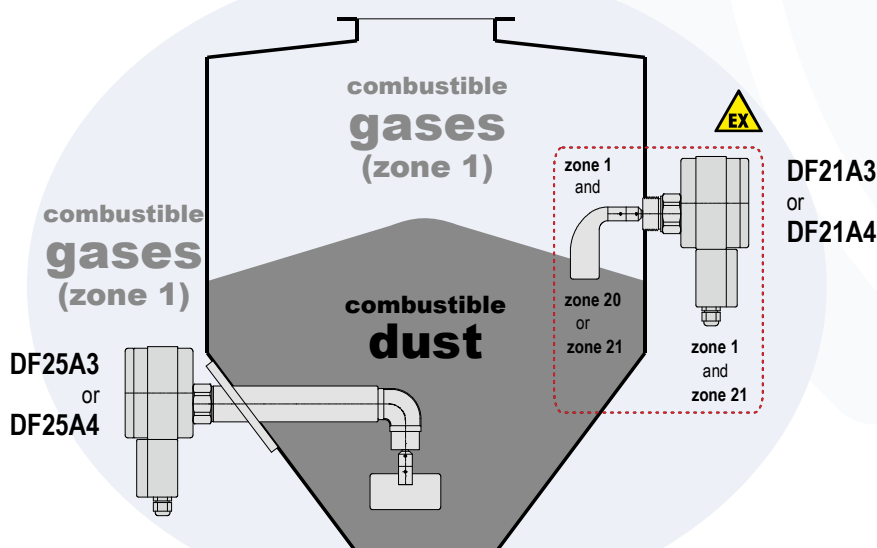

All combinations of the temperature decoupling bell housing  
with the pressure decoupling bell housing and  
in combination with the zone separating element are possible.

Gas+Dust  and **hybrid mixtures**

outgassing bulk goods

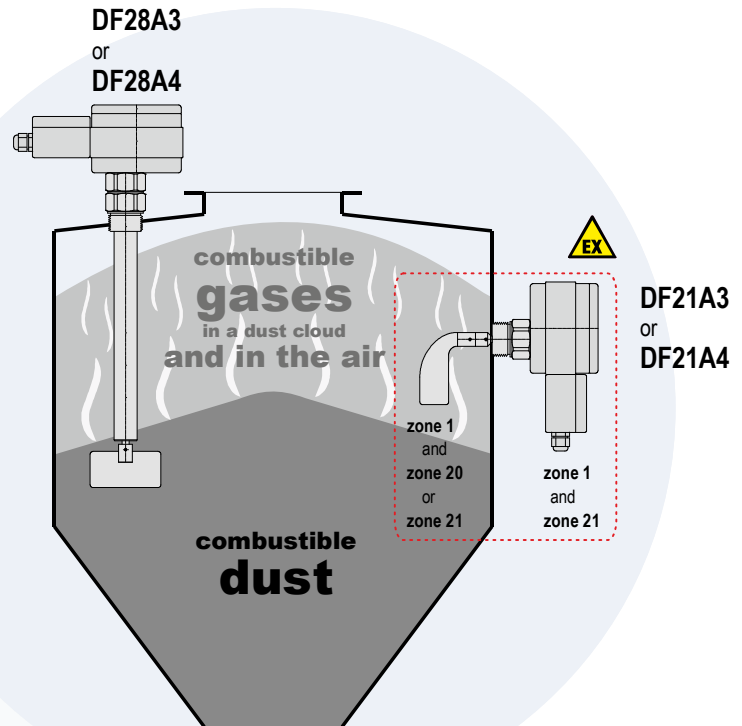

Temperature decoupling bell housing

Ex type of protection  II 1GD / 2GD c IIC T X see under DF-AB-08

Pressure decoupling bell housing

Ex type of protection  II 1GD / 2GD c IIC T X see under DF-AB-08

001-0526

Gas+Dust  and **hybrid mixtures**

if there is zone 0 inside

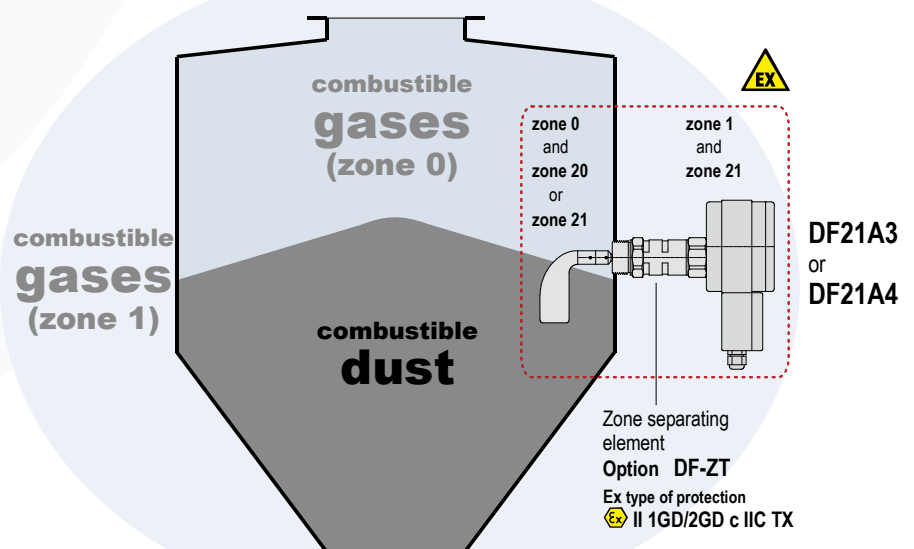

The zone separating element Ex type of protection  II 1GD/2GD c IIC TX  
is additional for use as a pressure decoupling

**Level measurement in a silo for grain**

